

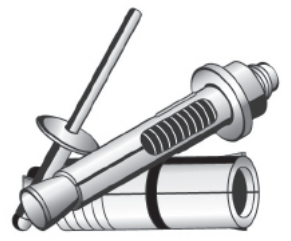

TOLEDO®



FIJACIÓN LISTA DE PRECIOS AGOSTO 2024











PIJAS

	FIJADORA COMBO.....1
	GALVANIZADA PUNTA AB.....1
	PLANA GALVANIZADA PUNTA AB.....2
	TABLAROCA CUERDA FINA...2
	PARA MADERA CON ARISTAS.....2
	PARA MADERA/ YESO MULTIUSOS.....2
	K-LATH PUNTA AGUDA.....3
	K-LATH PUNTA BROCA.....3
	HEXAGONAL GALVANIZADA PUNTA BROCA.....3
	PUNTA BROCA CON RONDANA EPDM.....3



TORNILLOS ANCLA PARA CONCRETO

	CABEZA PLANA PUNTA PHILLIPS.....4
	CONCRETO CABEZA HEXAGONAL.....4

ANCLAS Y TAQUETES

	ANCLA CAMISA ACERO INOXIDABLE.....5
	ANCLA ARPÓN ACERO INOXIDABLE.....5
	TAQUETE PARA TABLAROCA.....6
	ANCLA ROSCADA PARA MURO FALSO.....6
	TAQUETE EXPANSOR.....6
	TAQUETE EXPANSOR.....6
	TAQUETE DE GOLPE.....6
	TAQUETE DE GOLPE.....6
	PUNZÓN PARA TAQUETE.....6

ANCLAS Y TAQUETES

	ANCLA CAMISA.....6
	ANCLA ARPÓN.....7



FIJACIÓN EN NYLON

	TAQUETES.....8
	TAQUETE PARA TABLAROCA.....8
	GRAPAS DE NYLON.....8
	ABRAZADERAS.....8
	CINCHOS DE NYLON.....8

CHAVETAS

	CHAVETAS.....9
---	----------------



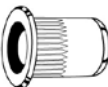

REMACHES TOLEDO

	ACERO INOXIDABLE.....10
	ALA ESTANDAR.....10
	ALA ANCHA.....10











TUERCAS REMACHABLES

	ZINCADA.....10
---	----------------

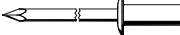

REMACHES INDUS

	ALA ESTANDAR -11 CAJA
	ALA ANCHA -11 CAJA
	ALA ESTANDAR -11 BOLSA
	ALA ANCHA -11 BOLSA
	DE COLOR.....12

REMACHES INDUS

	MULTIAGARRE.....12
	DE CLAVO SELLADO...12
	ACERO - ACERO.....12
	TRÉBOL ALUMINIO....12
	ESTRUCTURAL.....13
	DE GOLPE CARROCERO.....13
	REMACHE DE EXPANSIÓN.....14
	REMACHE PARA BALATA.....14
	REMACHES PARA CLUTCH.....14
	POSTES DE ALUMINIO.....14



GRASERAS INDUS

	ESTANDAR.....15
	MÉTRICAS.....15





OJILLOS PARA LONAS

15
---	---------

ANILLOS DE RETENCIÓN

	INTERNOS.....16
	EXTERNOS.....16
	TIPO E.....17

ABRAZADERAS

	LIBERTY.....19
	HS.....19
	TRABAJO PESADO.....20
	TRABAJO PESADO CON RESORTE.....20
	PARA BOTA DE TRANSMISIÓN...21

CLAVE	DESCRIPCIÓN	PRECIO POR PIEZA	E
PIJA FIJADORA COMBO GALVANIZADA PUNTA AB			
PF06009	#6 X 3/8	\$0.190	2500
PF06013	#6 X 1/2	\$0.210	2000
PF06016	#6 X 5/8	\$0.210	1000
PF06019	#6 X 3/4.	\$0.260	1000
PF06025	#6 X 1".	\$0.300	500

PF08013	#8 X 1/2	\$0.320	1000
PF08016	#8 X 5/8.	\$0.230	500
PF08019	#8 X 3/4.	\$0.320	500
PF08025	#8 X 1".	\$0.430	500
PF08032	#8 X 1.1/4.	\$0.580	250
PF08038	#8 X 1.1/2	\$0.560	250

PF10013	#10 X 1/2.	\$0.390	500
PF10016	#10 X 5/8.	\$0.350	500
PF10019	#10 X 3/4.	\$0.510	500
PF10025	#10 X 1".	\$0.590	250
PF10032	#10 X 1.1/4	\$0.860	250
PF10038	#10 X 1.1/2.	\$0.820	250
PF10051	#10 X 2".	\$1.120	200

CLAVE	DESCRIPCIÓN	PRECIO POR PIEZA	E
PIJA PLANA GALVANIZADA PUNTA AB			
PP06009	#6 X 3/8	\$0.160	2500
PP06013	#6 X 1/2	\$0.200	2500
PP06016	#6 X 5/8	\$0.210	2000
PP06019	#6 X 3/4.	\$0.210	1500
PP06025	#6 X 1".	\$0.360	1000
PP06038	#6 X 1.1/2.	\$0.560	500

PP08013	#8 X 1/2	\$0.340	1000
PP08019	#8 X 3/4.	\$0.310	1000
PP08025	#8 X 1".	\$0.420	500
PP08032	#8 X 1.1/4.	\$0.410	250
PP08038	#8 X 1.1/2	\$0.520	250
PP08051	#8 X 2"	\$0.670	250

PP10013	#10 X 1/2.	\$0.260	1000
PP10019	#10 X 3/4.	\$0.370	500
PP10025	#10 X 1".	\$0.480	400
PP10032	#10 X 1.1/4	\$0.570	250
PP10038	#10 X 1.1/2.	\$1.020	250
PP10051	#10 X 2".	\$0.850	200
PP10064	#10 X 2.1/2	\$1.640	100
PP10076	#10 X 3".	\$2.040	100

CLAVE	DESCRIPCIÓN	PRECIO POR PIEZA	E
PIJA PARA MADERA CON ARISTAS PUNTA 17 PHILLIPS NEGRA 			
PMA06025	#6 x 1"	\$0.270	5,000
PMA06032	#6 x 1.1/4	\$0.240	4,500
PMA06038	#6 x 1.1/2	\$0.300	3,500
PMA06051	#6 x 2"	\$0.480	2,000

PMA08025	#8 x 1"	\$0.620	3,750
PMA08032	#8 x 1.1/4	\$0.420	3,000
PMA08038	#8 x 1.1/2	\$0.370	2,500
PMA08044	#8 x 1.3/4	\$0.720	2,250
PMA08051	#8 x 2"	\$0.470	1,500
PMA08064	#8 x 2-1/2	\$1.030	1,000
PMA08076	#8 x 3"	\$1.000	750

PMA10038	#10 x 1.1/2	\$0.360	1,900
PMA10051	#10 x 2"	\$1.030	1,500
PMA10064	#10 x 2-1/2	\$1.120	800
PMA10076	#10 x 3"	\$1.070	600

PMA12064	#12 x 2-1/2	\$1.000	500
PMA12076	#12 x 3"	\$1.660	400

PIJA MULTIUSOS CUERDA ESTÁNDAR PHILLIPS NEGRA 			
PMU06019	#6 x 3/4	\$0.220	6,000
PMU06025	#6 x 1"	\$0.180	5,000
PMU06032	#6 x 1.1/4	\$0.290	4,000
PMU06038	#6 x 1.1/2	\$0.350	3,000
PMU06041	#6 x 1.5/8	\$0.320	2,500
PMU06044	#6 x 1.3/4	\$0.380	2,000
PMU06051	#6 x 2"	\$0.420	1,800
PMU06057	#6 x 2-1/4	\$0.480	1,500

CLAVE	DESCRIPCIÓN	PRECIO POR PIEZA	E
PIJA MULTIUSOS CUERDA ESTÁNDAR PHILLIPS NEGRA 			
PMU08025	#8 x 1"	\$0.310	3,750
PMU08032	#8 x 1-1/4	\$0.350	3,250
PMU08038	#8 x 1-1/2	\$0.430	2,750
PMU08051	#8 x 2"	\$0.420	1,500
PMU08064	#8 x 2-1/2	\$0.990	1,000
PMU08076	#8 x 3"	\$0.650	750

PMU10038	#10 x 1-1/2	\$0.760	2,100
PMU10051	#10 x 2"	\$0.600	1,350
PMU10064	#10 x 2-1/2	\$1.060	800
PMU10076	#10 x 3"	\$1.650	600
PMU10089	#10 x 3.1/2	\$2.300	500
PMU10102	#10 x 4"	\$2.280	400

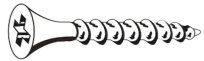
PIJA PARA TABLAROCA CUERDA FINA PHILLIPS NEGRA 			
PT06025	#6 X 1"	\$0.170	5,000
PT06032	#6 X 1.1/4	\$0.290	4,000
PT06038	#6 X 1.1/2	\$0.340	3,000
PT06041	#6 X 1.5/8	\$0.420	2,500
PT06051	#6 X 2"	\$0.590	2,000

PT08064	#8 X 2.1/2	\$0.560	1,000
PT08076	#8 X 3"	\$0.880	750

PT10089	#10 X 3.1/2	\$1.010	600
PT10102	#10 X 4"	\$1.060	400

CLAVE	DESCRIPCIÓN	PRECIO POR PIEZA	E
PIJA HEXAGONAL GALVANIZADA PUNTA BROCA			
PEB08013	#8 x 1/2	\$0.350	4,250
PEB08019	#8 x 3/4	\$0.330	3,250
PEB08025	#8 x 1"	\$0.530	2,750
PEB08032	#8 x 1-1/4	\$0.530	2,400
PEB08038	#8 x 1-1/2	\$0.780	2,000

PEB10013	#10 x 1/2	\$0.370	3,000
PEB10019	#10 x 3/4	\$0.560	2,400
PEB10025	#10 x 1"	\$0.650	1,900
PEB10038	#10 x 1-1/2	\$0.770	1,500

PEB12019	#12 x 3/4	\$0.640	1,250
PEB12025	#12 x 1"	\$0.660	1,000

PEB14019	#14 x 3/4	\$0.650	1,250
PEB14025	#14 x 1"	\$1.280	1,000
PEB14032	#14 x 1-1/4	\$1.380	850
PEB14038	#14 x 1-1/2	\$2.300	750
PEB14051	#14 x 2"	\$1.970	600

PIJA HEXAGONAL GALVANIZADA PUNTA BROCA CON RONDANA EPDM			
PEBR14019	#14 x 3/4	\$1.440	800
PEBR14025	#14 x 1"	\$1.920	800
PEBR14038	#14 x 1-1/2	\$1.720	700
PEBR14051	#14 x 2	\$2.540	500
PEBR14064	#14 x 2-1/2	\$4.110	400
PEBR14076	#14 x 3	\$2.100	300

CLAVE	DESCRIPCIÓN	PRECIO POR PIEZA	E
PIJA K-LATH PUNTA AGUDA GALVANIZADA PHILLIPS			
PK08013	#8 x 1/2	\$0.270	4,750
PK08019	#8 x 3/4	\$0.280	3,800
PK08025	#8 x 1"	\$0.380	3,000
PK08032	#8 x 1-1/4	\$0.280	2,500
PK08038	#8 x 1-1/2	\$0.500	2,000

PK10013	#10 x 1/2	\$0.240	3,250
PK10019	#10 x 3/4	\$0.470	2,100

PIJA K-LATH PUNTA BROCA GALVANIZADA PHILLIPS			
PKB08013	#8 x 1/2	\$0.330	4,000
PKB08019	#8 x 3/4	\$0.330	3,250
PKB08025	#8 x 1"	\$0.470	2,700
PKB08032	#8 x 1-1/4	\$0.540	2,400
PKB08038	#8 x 1-1/2	\$0.610	2,000
PKB08041	#8 x 1-5/8	\$0.460	1,850

CLAVE	DESCRIPCIÓN	PRECIO POR PIEZA	E
TORNILLOS PARA CONCRETO CABEZA HEXAGONAL			
FPCE632	1/4"x 1-1/4"	\$1.21	100
FPCE644	1/4"x 1-3/4"	\$2.13	100
FPCE657	1/4"x 2-1/4"	\$2.58	100
FPCE670	1/4"x 2-3/4"	\$2.58	100
FPCE683	1/4"x 3-1/4"	\$5.36	100
FPCE695	1/4"x 3-3/4"	\$6.61	100

CLAVE	DESCRIPCIÓN	PRECIO POR PIEZA	E
TORNILLOS PARA CONCRETO CABEZA PLANA PUNTA PHILLIPS			
FPCP632	1/4"x 1-1/4"	\$1.68	100
FPCP644	1/4"x 1-3/4"	\$2.07	100
FPCP657	1/4"x 2-1/4"	\$2.49	100
FPCP670	1/4"x 2-3/4"	\$2.08	100
FPCP683	1/4"x 3-1/4"	\$3.79	100
FPCP695	1/4"x 3-3/4"	\$6.45	100

SIN NECESIDAD DE TAQUETES
INSTALACIÓN

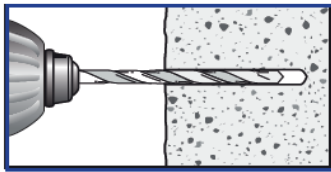

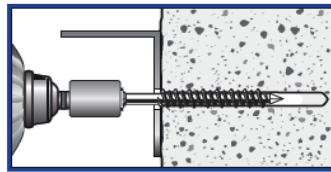

Perfore en el material base 1/2" más profundo que el empotramiento del anclaje, usando una broca de 3/16".

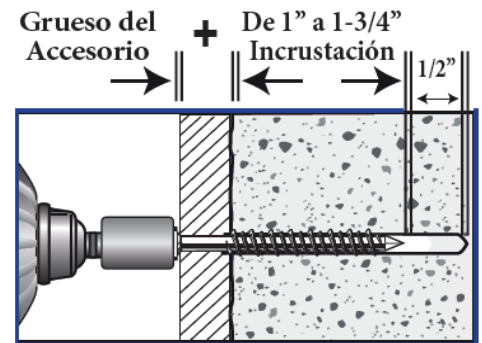

Inserte el Tornillo y Asegúrese de que penetre en el material base de 1" a 1-3/4". Use una punta Phillips #3 o una Llave de 5/16".

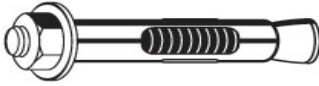

CLAVE	DESCRIPCIÓN	PRECIO POR PIEZA	E
ANCLA DE CAMISA ACERO INOXIDABLE 			
FXTC06035	1/4"x1 3/8"	\$14.82	100
FXTC06048	3/8"x1 7/8"	\$18.43	50
FXTC09076	3/8"x3"	\$22.60	50
FXTC13057	1/2"x2 1/4"	\$35.58	25
FXTC13101	1/2"x4"	\$54.56	25
FXTC16107	5/8"x4 1/4"	\$54.31	10

CLAVE	DESCRIPCIÓN	PRECIO POR PIEZA	E
ANCLA ARPÓN ACERO INOXIDABLE 			
FXTA06044	1/4"-20x1.3/4"	\$9.36	100
FXTA06057	1/4"-20x2.1/4"	\$10.84	100
FXTA06083	1/4"-20x3.1/4"	\$12.08	100

FXTA09057	3/8"-16x2.1/4"	\$17.62	50
FXTA09070	3/8"-16x2.3/4"	\$20.03	50
FXTA09076	3/8"-16x3"	\$21.84	50
FXTA09095	3/8"-16x3.3/4"	\$26.61	50
FXTA09127	3/8"-16x5"	\$26.06	50
FXTA09165	3/8"-16x6.1/2"	\$48.78	50

FXTA13070	1/2"-13x2.3/4"	\$37.77	25
FXTA13095	1/2"-13x3.3/4"	\$41.83	25
FXTA13108	1/2"-13x4.1/4"	\$48.61	25
FXTA13140	1/2"-13x5.1/2"	\$54.67	25
FXTA13178	1/2"-13x7"	\$73.67	25
FXTA13216	1/2"-13x8.1/2"	\$109.52	25
FXTA13254	1/2"-13x10"	\$106.92	25

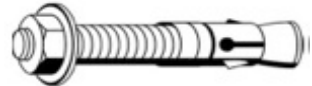
CLAVE	DESCRIPCIÓN	PRECIO POR PIEZA	E
ANCLA ARPÓN ACERO INOXIDABLE 			
FXTA16089	5/8"-11x3.1/2"	\$89.60	25
FXTA16114	5/8"-11x4.1/2"	\$90.47	25
FXTA16127	5/8"-11x5"	\$90.27	25
FXTA16152	5/8"-11x6"	\$107.18	20
FXTA16178	5/8"-11x7"	\$101.13	25
FXTA16216	5/8"-11x8 1/2"	\$108.49	25
FXTA16254	5/8"-11x10"	\$136.87	10

FXTA19108	3/4"-10x4.1/4"	\$175.37	20
FXTA19121	3/4"-10x4.3/4"	\$202.30	20
FXTA19140	3/4"-10x5.1/2"	\$181.28	20
FXTA19158	3/4"-10x6.1/4"	\$202.45	10
FXTA19178	3/4"-10x7"	\$195.70	10
FXTA19216	3/4"-10x8.1/2"	\$159.59	10
FXTA19254	3/4"-10x10"	\$294.81	10

CLAVE	DESCRIPCIÓN	PRECIO POR PIEZA	E
TAQUETE PARA TABLAROCA TOGGLER 			
F TTL06	Taquete Auto perforante	\$6.62	100

CLAVE	DESCRIPCIÓN	PRECIO POR PIEZA	E
ANCLA ROSCADA PARA PANELES 			
FTR05	Ancla Roscada 3/16"-24	\$25.23	50
FTR06	Ancla Roscada 1/4"-20	\$25.23	50

CLAVE	DESCRIPCIÓN	PRECIO POR PIEZA	E
TAQUETE EXPANSOR ZINCADO 			
FTZ05	3/16 - 24	\$9.15	100
FTZ06	1/4-20.	\$15.83	100
FTZ08	5/16-18.	\$18.68	50
FTZ09	3/8-16.	\$23.30	50
FTZ13	1/2-13.	\$44.29	25

CLAVE	DESCRIPCIÓN	PRECIO POR PIEZA	E
TAQUETE DE EXPANSIÓN 			
FTE08	5/16-18.	\$0.51	100
FTE19	3/4-10.	\$2.89	100

CLAVE	DESCRIPCIÓN	PRECIO POR PIEZA	E
TAQUETE DE GOLPE 			
FTG06	1/4-20 - 3/8 -1".	\$3.30	100
FTG09	3/8-16 - 1/2 -1.9/16	\$5.24	50
FTG13	1/2-13 - 5/8 - 2".	\$7.65	50
FTG16	5/8-11 - 7/8 - 2.1/2.	\$21.64	25
FTG19	3/4-10 - 1" - 3.1/8	\$34.54	25

CLAVE	DESCRIPCIÓN	PRECIO POR PIEZA	E
PUNZÓN PARA TAQUETE DE GOLPE 			
FTGP06	1/4.	\$15.26	20
FTGP08	3/8.	\$21.92	10
FTGP13	1/2.	\$60.76	10
FTGP16	5/8.	\$32.71	5
FTGP19	3/4.	\$41.82	5

CLAVE	DESCRIPCIÓN	PRECIO POR PIEZA	E
ANCLA DE CAMISA 			
FTC06057	1/4-20 X 2.1/4	\$3.42	100
FTC08064	5/16-18 X 2.1/2	\$5.09	50
FTC09076	3/8-16 X 3".	\$7.38	50
FTC13076	1/2-13 X 3".	\$11.81	25
FTC13152	1/2"x6"	\$20.81	25
FTC16108	5/8"x4 1/4"	\$30.42	20
FTC19108	3/4"x4 1/4"	\$46.57	10

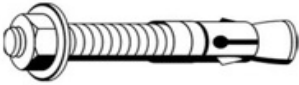
CLAVE	DESCRIPCIÓN	PRECIO POR PIEZA	E
ANCLA ARPÓN			
FTA06044	1/4-20 X 1.3/4	\$3.51	100
FTA06057	1/4-20 X 2.1/4	\$3.71	100
FTA06076	1/4-20 X 3".	\$3.78	100

FTA08051	5/16-18 X 2".	\$4.23	50
FTA08070	5/16-18 X 2.3/4	\$5.04	50
FTA08089	5/16-18 X 3.1/2	\$5.47	50

FTA09057	3/8-16 X 2.1/4	\$6.89	50
FTA09070	3/8-16 X 2.3/4	\$7.60	50
FTA09076	3/8-16 X 3".	\$7.99	50
FTA09089	3/8-16 X 3.1/2	\$8.69	50
FTA09095	3/8-16 X 3.3/4	\$8.81	50
FTA09127	3/8-16 X 5".	\$10.71	50
FTA09165	3/8"-16x6 1/2"	\$11.88	50

FTA13070	1/2-13 X 2.3/4	\$13.12	25
FTA13095	1/2-13 X 3.3/4	\$15.48	25
FTA13114	1/2-13 X 4.1/2	\$15.94	25
FTA13140	1/2-13 X 5.1/2	\$18.27	25
FTA13178	1/2-13 X 7".	\$22.41	25
FTA13216	1/2"-13x8 1/2"	\$31.74	25
FTA13254	1/2"-13x10"	\$39.00	25

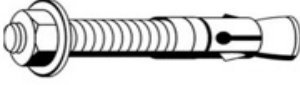
CLAVE	DESCRIPCIÓN	PRECIO POR PIEZA	E
ANCLA ARPÓN			
FTA16089	5/8-11 X 3.1/2	\$24.81	25
FTA16114	5/8-11 X 4.1/2	\$29.15	20
FTA16127	5/8-11 X 5".	\$31.03	20
FTA16152	5/8-11 X 6".	\$35.28	20
FTA16178	5/8-11 X 7".	\$36.69	20
FTA16216	5/8"-11x8 1/2"	\$46.40	20
FTA16254	5/8"-11x10"	\$58.08	20

FTA19108	3/4-10 X 4.1/4	\$43.08	10
FTA19121	3/4-10 X 4.3/4	\$50.31	10
FTA19140	3/4-10 X 5.1/2	\$51.56	10
FTA19158	3/4-10 X 6.1/4	\$58.93	10
FTA19178	3/4-10 X 7".	\$59.95	10
FTA19216	3/4-10 X 8.1/2.	\$63.12	10
FTA19254	3/4"-10x10"	\$73.01	10
FTA19305	3/4"-10x12"	\$99.35	10

FTA22152	7/8"-9x6"	\$86.01	5
FTA22203	7/8"-9x8"	\$107.08	5
FTA22254	7/8"-9x10"	\$117.52	5

FTA25152	1"-8x6"	\$117.00	5
FTA25229	1"-8x9"	\$199.28	5
FTA25305	1"-8x12"	\$171.23	5

CLAVE	DESCRIPCIÓN	PRECIO POR PIEZA	E
TAQUETES COLOR NEGRO			
FDP005	3/16"	\$0.456	100
FDP006	1/4"	\$0.568	100
FDP006L	1/4" L	\$0.841	100
FDP008	5/16"	\$0.688	100
FDP009	3/8"	\$1.053	100
FDP013	1/2"	\$1.641	25

TAQUETE PARA TABLAROCA NYLON BLANCO			
FDT012	1/2	\$1.059	100

GRAPAS DE NYLON			
FDGC350	Cuadrada 350 Azul	\$0.613	100
FDGC460	Cuadrada 460 Naranja	\$0.686	100
FDGC580	Cuadrada 580 Roja	\$0.860	100
FDGC610	Cuadrada 610 Amarilla	\$1.049	100
FDGR710	Redonda 710 Verde	\$0.920	100

ABRAZADERAS DE NYLON			
FDAG13	Gris 1/2	\$2.635	25
FDAG19	Gris 3/4	\$3.022	25
FDAG25	Gris 1"	\$3.487	25
FDAV13	Verde 1/2	\$2.635	25
FDAV19	Verde 3/4	\$3.022	25
FDAV25	Verde 1"	\$3.487	25

CLAVE	DESCRIPCIÓN	PRECIO POR PIEZA	E
CINCHOS DE NYLON COLOR NATURAL (BLANCO)			
FDB3100	2.5 x 100 mm	\$0.150	100
FDB3150	2.5 x 150 mm	\$0.253	100
FDB3200	2.5 x 200 mm	\$0.310	100
FDB4150	3.6 x 150 mm	\$0.397	100
FDB4200	3.6 x 200 mm	\$0.526	100
*FDB4280	3.6 x 280 mm	\$1.300	100
FDB4370	3.6 x 370 mm	\$1.337	100
FDB5200	4.8 x 200 mm	\$0.895	100
FDB5280	4.8 x 280 mm	\$1.061	100
FDB5370	4.8 x 370 mm	\$1.612	100
FDB5430	4.8 x 430 mm	\$1.900	100
FDB8530	7.8 x 530 mm	\$5.900	100

CINCHOS DE NYLON COLOR NEGRO			
FDN3100	2.5 x 100 mm	\$0.150	100
FDN3150	2.5 x 150 mm	\$0.253	100
FDN3200	2.5 x 200 mm	\$0.310	100
FDN4150	3.6 x 150 mm	\$0.397	100
FDN4200	3.6 x 200 mm	\$0.526	100
*FDN4280	3.6 x 280 mm	\$1.300	100
FDN4370	3.6 x 370 mm	\$1.337	100
FDN5200	4.8 x 200 mm	\$0.895	100
FDN5280	4.8 x 280 mm	\$1.061	100
FDN5370	4.8 x 370 mm	\$1.612	100
FDN5430	4.8 x 430 mm	\$1.900	100
*FDN8380	7.8 x 380 mm	\$4.500	100

*Por discontinuar

CLAVE	DESCRIPCIÓN	PRECIO POR PIEZA	E
CHAVETAS			
			
FC01013	1/16 X 1/2.	\$0.440	800
FC01019	1/16 X 3/4	\$0.510	400
FC01025	1/16 X 1".	\$0.630	300
FC01032	1/16 X 1.1/4.	\$0.730	200
FC01038	1/16 X 1.1/2.	\$0.870	100
FC01051	1/16 X 2"	\$1.420	100

FC02013	3/32 X 1/2.	\$0.450	300
FC02019	3/32 X 3/4	\$0.500	200
FC02025	3/32 X 1".	\$0.630	100
FC02032	3/32 X 1.1/4.	\$0.710	100
FC02038	3/32 X 1.1/2.	\$0.840	100
FC02051	3/32 X 2".	\$1.010	50

FC03013	1/8 X 1/2	\$0.630	250
FC03019	1/8 X 3/4	\$0.780	150
FC03025	1/8 X 1".	\$0.890	100
FC03032	1/8 X 1.1/4	\$1.050	100
FC03038	1/8 X 1.1/2	\$1.170	100
FC03051	1/8 X 2"	\$1.520	100
FC03064	1/8 X 2.1/2	\$1.820	50
FC03076	1/8 X 3".	\$2.130	50

FC04013	5/32 X 1/2.	\$0.840	150
FC04019	5/32 X 3/4.	\$1.010	100
FC04025	5/32 X 1".	\$1.250	100
FC04032	5/32 X 1.1/4	\$1.450	100
FC04038	5/32 X 1.1/2	\$1.750	100
FC04051	5/32 X 2".	\$2.090	50
FC04064	5/32 X 2.1/2.	\$2.470	50
FC04076	5/32 X 3".	\$2.880	30

CLAVE	DESCRIPCIÓN	PRECIO POR PIEZA	E
CHAVETAS			
			
FC05013	3/16 X 1/2.	\$1.120	200
FC05019	3/16 X 3/4.	\$1.560	150
FC05025	3/16 X 1"	\$1.850	150
FC05032	3/16 X 1.1/4.	\$2.220	100
FC05038	3/16 X 1.1/2	\$2.540	100
FC05051	3/16 X 2"	\$3.070	80
FC05064	3/16 X 2.1/2	\$3.740	50
FC05076	3/16 X 3".	\$4.260	50
FC05089	3/16 X 3.1/2	\$4.910	50
FC05102	3/16 X 4".	\$5.320	50

FC06025	1/4 X 1"	\$2.960	150
FC06032	1/4 X 1.1/4	\$3.230	150
FC06038	1/4 X 1.1/2.	\$3.980	100
FC06051	1/4 X 2"	\$4.710	100
FC06064	1/4 X 2.1/2.	\$5.630	50
FC06076	1/4 X 3"	\$6.580	50
FC06089	1/4 X 3.1/2.	\$7.680	50
FC06102	1/4 X 4"	\$9.030	50

FC08025	5/16 X 1"	\$4.430	100
FC08032	5/16 X 1.1/4	\$4.890	100
FC08038	5/16 X 1.1/2.	\$5.850	100
FC08051	5/16 X 2"	\$6.830	50
FC08064	5/16 X 2.1/2.	\$8.500	50
FC08076	5/16 X 3"	\$9.740	50
FC08089	5/16 X 3.1/2.	\$11.210	50
FC08102	5/16 X 4"	\$12.560	50

FC09038	3/8 X 1.1/2.	\$9.550	50
FC09051	3/8 X 2"	\$11.570	50
FC09064	3/8 X 2.1/2.	\$13.340	50
FC09076	3/8 X 3"	\$15.920	25
FC09089	3/8 X 3.1/2.	\$18.750	25
FC09102	3/8 X 4"	\$21.620	25

CLAVE	DESCRIPCIÓN	PRECIO POR PIEZA	E
REMACHES TOLEDO ACERO INOXIDABLE			
			
FXR41	1/8 X 3/16 X (1/16)	\$0.66	100
FXR42	1/8 X 1/4 X (1/8).	\$0.93	100
FXR43	1/8 X 5/16 X (3/16).	\$0.97	100
FXR44	1/8 X 3/8 X (1/4).	\$1.05	100
FXR45	1/8 X 7/16 X (5/16).	\$1.17	100
FXR46	1/8 X 1/2 X (3/8).	\$1.13	100
FXR48	1/8 X 5/8 X (1/2).	\$1.32	100

FXR52	5/32 X 1/4 X (1/8).	\$1.35	100
FXR54	5/32 X 3/8 X (1/4).	\$1.52	100
FXR56	5/32 X 1/2 X (3/8).	\$1.79	100
FXR58	5/32 X 5/8 X (1/2).	\$1.95	100
FXR510	5/32 X 3/4 X (5/8).	\$2.10	100

FXR62	3/16 X 1/4 X (1/8).	\$2.12	100
FXR64	3/16 X 3/8 X (1/4).	\$2.22	100
FXR66	3/16 X 1/2 X (3/8).	\$2.37	100
FXR68	3/16 X 5/8 X (1/2).	\$2.68	100
FXR610	3/16 X 3/4 X (5/8).	\$2.96	50
FXR612	3/16 X 7/8 X (3/4).	\$3.53	50

FXR84	1/4 X 3/8 X (1/4).	\$4.25	50
FXR86	1/4 X 1/2 X (3/8).	\$5.00	50
FXR88	1/4 X 5/8 X (1/2).	\$5.63	50

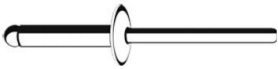
REMACHES DE CLAVO ALUMINIO /ACERO TOLEDO ALA ESTÁNDAR			
			
FR41	1/8 X 3/16 X (1/16)	\$0.260	1,000
FR42	1/8 X 1/4 X (1/8).	\$0.260	1,000
FR43	1/8 X 5/16 X (3/16).	\$0.280	1,000
FR44	1/8 X 3/8 X (1/4).	\$0.280	1,000
FR45	1/8 X 7/16 X (5/16).	\$0.290	1,000
FR46	1/8 X 1/2 X (3/8).	\$0.300	1,000
FR48	1/8 X 5/8 X (1/2).	\$0.340	1,000
FR410	1/8 X 3/4 X (5/8).	\$0.370	1,000

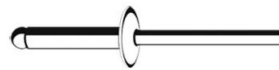
CLAVE	DESCRIPCIÓN	PRECIO POR PIEZA	E
REMACHES DE CLAVO ALUMINIO/ ACERO TOLEDO ALA ESTÁNDAR			
			
FR52	5/32 X 1/4 X (1/8).	0.350	1,000
FR54	5/32 X 3/8 X (1/4).	0.390	1,000
FR56	5/32 X 1/2 X (3/8).	0.430	1,000
FR58	5/32 X 5/8 X (1/2).	0.490	500
FR510	5/32 X 3/4 X (5/8).	0.530	500
FR512	5/32 X 7/8 X (3/4).	0.580	500

FR62	3/16 X 1/4 X (1/8).	0.520	500
FR64	3/16 X 3/8 X (1/4).	0.560	500
FR66	3/16 X 1/2 X (3/8).	0.640	500
FR68	3/16 X 5/8 X (1/2).	0.700	500
FR610	3/16 X 3/4 X (5/8).	0.770	250
FR612	3/16 X 7/8 X (3/4).	0.840	250
FR614	3/16 X 1 X (7/8).	0.950	250
FR616	3/16 X 1.1/8 X (1").	1.000	250

FR84	1/4 X 3/8 X (1/4).	1.220	350
FR86	1/4 X 1/2 X (3/8).	1.310	350
FR88	1/4 X 5/8 X (1/2).	1.470	300

REMACHE TOLEDO ALA ANCHA			
FRL64	3/16 X 3/8 X (1/4).	0.950	250
FRL66	3/16 X 1/2 X (3/8).	1.030	250
FRL68	3/16 X 5/8 X (1/2).	1.100	250
FRL610	3/16 X 3/4 X (5/8).	1.190	250
FRL612	3/16 X 7/8 X (3/4).	1.230	250

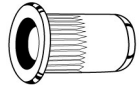
TUERCAS REMACHABLES TOLEDO ZINCADA			
			
FNR05	#10-24X0.475"	\$2.83	100
FNR05L	#10-24X0.585"L	\$3.07	100
FNR06	1/4-20X0.58"	\$3.63	100
FNR06L	1/4-20X0.68"L	\$4.08	100
FNR08	5/16-18X0.69"	\$7.08	100
FNR08L	5/16-18X0.805"L	\$7.15	100
FNR09	3/8-16X0.69"	\$6.56	100
FNR09L	3/8-16X0.805"L	\$7.13	100

CLAVE	DESCRIPCIÓN	PRECIO POR PIEZA	E
REMACHES DE CLAVO ALUMINIO/ ACERO EN CAJA INDUSX ALA ESTÁNDAR			
			
FN32	AS-32 (3/32" x 2/16")	\$0.526	2,000
FN34	AS-34 (3/32" x 4/16")	\$0.533	2,000
FN41	AS-41 (1/8" x 1/16")	\$0.537	1,000
FN42	AS-42 (1/8" x 2/16")	\$0.561	1,000
FN43	AS-43 (1/8" x 3/16")	\$0.576	1,000
FN44	AS-44 (1/8" x 4/16")	\$0.592	1,000
FN45	AS-45 (1/8" x 5/16")	\$0.608	1,000
FN46	AS-46 (1/8" x 6/16")	\$0.615	1,000
FN48	AS-48 (1/8" x 8/16")	\$0.665	1,000
FN52	AS-52 (5/32" x 2/16")	\$0.815	1,000
FN54	AS-54 (5/32" x 4/16")	\$0.861	1,000
FN56	AS-56 (5/32" x 6/16")	\$0.908	1,000
FN58	AS-58 (5/32" x 8/16")	\$0.994	500
FN59	AS-510 (5/32" x 10/16")	\$1.062	500
FN62	AS-62 (3/16" x 2/16")	\$1.105	500
FN64	AS-64 (3/16" x 4/16")	\$1.221	500
FN66	AS-66 (3/16" x 6/16")	\$1.304	500
FN68	AS-68 (3/16" x 8/16")	\$1.510	500
FN610	AS-610 (3/16" x 10/16")	\$1.564	500
FN612	AS-612 (3/16" x 12/16")	\$1.760	500
FN614	AS-614 (3/16" x 14/16")	\$1.978	200
FN616	AS-616 (3/16" x 16/16")	\$2.063	200
FN84	AS-84 (1/4" x 4/16")	\$1.973	200
FN86	AS-86 (1/4" x 6/16")	\$2.045	200
FN88	AS-88 (1/4" x 8/16")	\$2.367	200

CLAVE	DESCRIPCIÓN	PRECIO POR PIEZA	E
REMACHES DE CLAVO ALUMINIO/ ACERO EN BOLSA INDUSX ALA ESTÁNDAR			
			
FNB32	AS-32 (3/32" x 2/16")	\$0.555	100
FNB34	AS-34 (3/32" x 4/16")	\$0.561	100
*FNB41	AS-41 (1/8" x 1/16")	\$0.490	100
FNB42	AS-42 (1/8" x 2/16")	\$0.584	100
FNB43	AS-43 (1/8" x 3/16")	\$0.605	100
FNB44	AS-44 (1/8" x 4/16")	\$0.621	100
FNB45	AS-45 (1/8" x 5/16")	\$0.637	100
FNB46	AS-46 (1/8" x 6/16")	\$0.644	100
FNB48	AS-48 (1/8" x 8/16")	\$0.701	100
FNB52	AS-52 (5/32" x 2/16")	\$0.854	100
FNB54	AS-54 (5/32" x 4/16")	\$0.901	100
FNB56	AS-56 (5/32" x 6/16")	\$0.949	100
FNB58	AS-58 (5/32" x 8/16")	\$1.018	100
FNB510	AS-510 (5/32" x 10/16")	\$1.115	100
FNB62	AS-62 (3/16" x 2/16")	\$1.161	100
FNB64	AS-64 (3/16" x 4/16")	\$1.267	100
FNB66	AS-66 (3/16" x 6/16")	\$1.352	100
FNB68	AS-68 (3/16" x 8/16")	\$1.562	100
FNB610	AS-610 (3/16" x 10/16")	\$1.670	100
FNB612	AS-612 (3/16" x 12/16")	\$1.791	100
FNB614	AS-614 (3/16" x 14/16")	\$2.010	100
FNB616	AS-616 (3/16" x 16/16")	\$2.152	100
FNB84	AS-84 (1/4" x 4/16")	\$2.005	100
FNB86	AS-86 (1/4" x 6/16")	\$2.114	100
FNB88	AS-88 (1/4" x 8/16")	\$2.399	100

REMACHE INDUSX ALA ANCHA EN CAJA			
FNA66	AS-66 (3/16" x 6/16") CA	\$1.944	500
FNA68	AS-68 (3/16" x 8/16") CA	\$2.081	200
FNA610	AS-610 (3/16" x 10/16") CA	\$2.258	200
FNA612	AS-612 (3/16" x 12/16") CA	\$2.493	200
FNA614	AS-614 (3/16" x 14/16") CA	\$2.802	200
FNA616	AS-616 (3/16" x 16/16") CA	\$3.026	200

REMACHE INDUSX ALA ANCHA EN BOLSA			
FNAB66	AS-66 (3/16" x 6/16") CA	\$2.044	100
FNAB68	AS-68 (3/16" x 8/16") CA	\$2.174	100
FNAB610	AS-610 (3/16" x 10/16")CA	\$2.378	100
FNAB612	AS-612 (3/16" x 12/16") CA	\$2.571	100

*Por discontinuar

CLAVE	DESCRIPCIÓN	PRECIO POR PIEZA	E
REMACHES DE CLAVO ALUMINIO/ ACERO DE COLOR INDUS ALA ESTÁNDAR			
			
FNB430AN	AS-43 (1/8" x 3/16") NEGRO	\$0.672	100
FNB430AU	AS-43 (1/8" x 3/16") ORO	\$0.667	100
FNB430BL	AS-43 (1/8" x 3/16") BLANCO	\$0.650	100
FNB430BR	AS-43 (1/8" x 3/16") BRONCE	\$0.667	100
FNB440AN	AS-44 (1/8" x 4/16") NEGRO	\$0.672	100
FNB440AU	AS-44 (1/8" x 4/16") ORO	\$0.667	100
FNB440BL	AS-44 (1/8" x 4/16") BLANCO	\$0.650	100
FNB440BR	AS-44 (1/8" x 4/16") BRONCE	\$0.667	100
FNB450AN	AS-45 (1/8" x 5/16") NEGRO	\$0.713	100
FNB450AU	AS-45 (1/8" x 5/16") ORO	\$0.706	100
FNB450BL	AS-45 (1/8" x 5/16") BLANCO	\$0.704	100
FNB450BR	AS-45 (1/8" x 5/16") BRONCE	\$0.707	100
FNB450CH	AS-45 (1/8" x 5/16") CHAMPAGNE	\$0.827	100
FNB460AN	AS-46 (1/8" x 6/16") NEGRO	\$0.723	100
FNB460AU	AS-46 (1/8" x 6/16") ORO	\$0.716	100
FNB460BL	AS-46 (1/8" x 6/16") BLANCO	\$0.714	100
FNB460CH	AS-46 (1/8" x 6/16") CHAMPAGNE	\$0.845	100
FNB480AN	AS-48 (1/8" x 8/16") NEGRO	\$0.783	100
FNB480AU	AS-48 (1/8" x 8/16") ORO	\$0.776	100
FNB480BL	AS-48 (1/8" x 8/16") BLANCO	\$0.775	100
FNB480BR	AS-48 (1/8" x 8/16") BRONCE	\$0.776	100
FNB480CH	AS-46 (1/8" x 8/16") CHAMPAGNE	\$0.913	100
FNB540AN	AS-54 (5/32" x 4/16") NEGRO	\$0.999	100
FNB540AU	AS-54 (5/32" x 4/16") ORO	\$0.991	100
FNB540BL	AS-54 (5/32" x 4/16") BLANCO	\$0.987	100
FNB540BR	AS-54 (5/32" x 4/16") BRONCE	\$0.991	100
FNB540CH	AS-54 (5/32" x 4/16") CHAMPAGNE	\$0.987	100
FNB560AN	AS-56 (5/32" x 6/16") NEGRO	\$1.061	100
FNB560AU	AS-56 (5/32" x 6/16") ORO	\$1.051	100
FNB560BL	AS-56 (5/32" x 6/16") BLANCO	\$1.050	100
FNB560BR	AS-56 (5/32" x 6/16") BRONCE	\$1.050	100
FNB560CH	AS-56 (5/32" x 6/16") CHAMPAGNE	\$1.251	100
FNB680AN	AS-68 (3/16" x 8/16") NEGRO	\$1.759	100

CLAVE	DESCRIPCIÓN	PRECIO POR PIEZA	E
REMACHE DE CLAVO MULTIAGARRE INDUS			
			
FNMA640	6-40 6/32"X4/16"	\$1.494	500
FNMA660	6-60 6/32X6/16	\$1.693	500
FNMA680	6-80 6/32"X8/16"	\$1.833	500

CLAVE	DESCRIPCIÓN	PRECIO POR PIEZA	E
REMACHE DE CLAVO SELLADO INDUS			
			
FNSD640	AS-64 3/16" x 4/16"	\$2.500	500
FNSD660	AS-66 3/16" x 6/16"	\$2.790	500
FNSD680	AS-68 3/16" x 8/16"	\$2.820	500

CLAVE	DESCRIPCIÓN	PRECIO POR PIEZA	E
REMACHES DE CLAVO ACERO - ACERO INDUS			
			
FNZ420	SS-42 1/8" X 2/16"	\$0.740	1,000
*FNZ44	SS-44 1/8" X 2/16"	\$0.590	1,000
FNZ66	SS-66 3/16" x 6/16"	\$1.888	500
FNZ66CA	SS-66 3/16" x 6/16" CA	\$2.246	200
FNZ680	SS-68 3/16" x 8/16"	\$2.188	500
FNZ840	SS-84 1/4" x 4/16" ZI	\$3.163	200

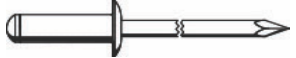
CLAVE	DESCRIPCIÓN	PRECIO POR PIEZA	E
REMACHE TRÉBOL ALUMINIO			
			
FNTA52	52 (5/32" x 2/16")	\$4.37	100
FNTA54	54 (5/32" x 4/16")	\$4.41	100
FNTA56	56 (5/32" x 6/16")	\$4.53	100
FNTA62	62 (3/16" x 2/16")	\$4.83	100
FNTA64	64 (3/16" x 4/16")	\$5.47	100
FNTA66	66 (3/16" x 6/16")	\$5.70	100
FNTA68	68 (3/16" x 8/16")	\$6.77	100

*Por discontinuar

CLAVE	DESCRIPCIÓN	PRECIO POR PIEZA	E
REMACHE ESTRUCTURAL SERIE LOCK			
FNEL66	66 (3/16" x 6/16")	\$10.24	100
FNEL68	68 (3/16" x 8/16")	\$12.75	100
FNEL610	610 (3/16" x 10/16")	\$10.97	100
FNEL6	86 (1/4" x 6/16")	\$12.36	100

CLAVE	DESCRIPCIÓN	PRECIO POR PIEZA	E
REMACHE ESTRUCTURAL SERIE BULBO			
FNEB64	64 (3/16" x 4/16")	\$10.97	100
FNEB66	66 (3/16" x 6/16")	\$11.43	100
FNEB86	86 (1/4" x 6/16")	\$12.67	100
FNEB810	810 (1/4" x 10/16")	\$14.06	100

CLAVE	DESCRIPCIÓN	PRECIO POR PIEZA	E
REMACHE PARA BALATA			
FNTB0303	3-3 (.145 * 3/16")	\$0.178	1000
FNTB0404	4-4 (.145 x 4/16")	\$0.218	1000
FNTB0703	7-3 (3/16"x 3/16")	\$0.276	1000
FNTB0704	7-4 (3/16" x 4/16")	\$0.296	1000
FNTB0707	7-7 (3/16" x 7/16")	\$0.420	1000
FNTB0708	7-8 (3/16" x 8/16")	\$0.489	1000
FNTB0818	8-18 (.315 x 47/16")	\$2.079	500
FNTB1009	10-9 (1/4" x 9/16")	\$0.964	500
FNTB1010	10-10 (1/4" x 10/16")	\$1.017	500
FNTB1010A	10-10 (1/4" x 12/16") AL	\$1.357	500

CLAVE	DESCRIPCIÓN	PRECIO POR PIEZA	E
REMACHES PARA CLUTCH			
FNTC43	43 DIAF MERC. BENZ 40" (.315 x 1")	\$8.26	500
FNTC47	47 TACON CHICO X 4 (3/8" x 11/32")	\$2.31	500

CLAVE	DESCRIPCIÓN	PRECIO POR PIEZA	E
REMACHE DE GOLPE CARROCERO INDUS			
FNQ2215	SUAVE 5/32 X 1/4	\$809.00	1 Kg.
FNQ2220	SUAVE 5/32 X 3/8	\$809.00	1 Kg.
FNQ2223	SUAVE 5/32 X 5/8	\$809.00	1 Kg.
FNQ2226	SUAVE 5/32 X 3/4	\$809.00	1 Kg.
FNQ2228	SUAVE 5/32 X 1"	\$809.00	1 Kg.
FNQ2235	SUAVE 3/16 X 1/4	\$591.00	1 Kg.
FNQ2252	SUAVE 3/16 X 3/8	\$591.00	1 Kg.
FNQ2274	SUAVE 3/16 X 1/2	\$591.00	1 Kg.
FNQ2288	SUAVE 3/16 X 5/8	\$592.00	1 Kg.
FNQ2296	SUAVE 3/16 X 3/4	\$592.00	1 Kg.
FNQ2305	SUAVE 3/16 X 1"	\$592.00	1 Kg.
FNQ2320	SUAVE 1/4 X 3/8	\$593.00	1 Kg.
FNQ2330	SUAVE 1/4 X 1/2	\$593.00	1 Kg.
FNQ2342	SUAVE 1/4 X 5/8	\$593.00	1 Kg.
FNQ2353	SUAVE 1/4 X 3/4	\$593.00	1 Kg.
FNQ2359	SUAVE 1/4 X 7/8	\$765.00	1 Kg.
FNQ2364	SUAVE 1/4 X 1"	\$593.00	1 Kg.
FNY2254	DURO 3/16 X 3/8	\$1,095.00	1 Kg.
FNY2276	DURO 3/16 X 1/2	\$1,095.00	1 Kg.
FNY2289	DURO 3/16 X 5/8	\$1,264.00	1 Kg.
FNY2331	DURO 1/4 X 1/2	\$1,096.00	1 Kg.
FNY2343	DURO 1/4 X 5/8	\$1,096.00	1 Kg.
FNY2354	DURO 1/4 X 3/4	\$1,266.00	1 Kg.
FNY6936	DURO 1/4 X 7/8	\$1,266.00	1 Kg.
FNY2389	DURO 3/8 X 3/4	\$1,487.00	1 Kg.

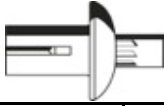
CLAVE	DESCRIPCIÓN	PRECIO POR PIEZA	E
REMACHE DE EXPANSIÓN			
FNE03103	3-1-03	\$3.12	1,000
FNE03105	3-1-05	\$3.59	1,000
FNE03107	3-1-07	\$3.94	1,000
FNE03109	3-1-09	\$4.13	1,000
FNE03111	3-1-11	\$4.25	1,000
FNE03113	3-1-13	\$4.25	1,000
FNE03115	3-1-15	\$4.25	1,000
FNE03117	3-1-17	\$4.13	1,000
FNE03204	3-2-04	\$4.29	1,000
FNE03206	3-2-06	\$4.60	1,000
FNE03208	3-2-08	\$4.94	1,000
FNE04103	4-1-03	\$4.99	1,000
FNE04105	4-1-05	\$5.45	500
FNE04107	4-1-07	\$5.99	500
FNE04109	4-1-09	\$6.32	500
FNE04111	4-1-11	\$6.83	500
FNE04113	4-1-13	\$7.42	500
FNE04115	4-1-15	\$7.95	500
FNE04117	4-1-17	\$8.56	500

CLAVE	DESCRIPCIÓN	PRECIO POR PIEZA	E
POSTES DE ALUMINIO			
FNP06	6mm 1/4"	\$3.68	100
FNP09	9mm 3/8"	\$4.10	100
FNP12	12mm 1/2"	\$4.16	100
FNP15	15mm 5/8"	\$4.52	100
FNP19	19mm 3/4"	\$5.37	100
FNP25	25mm 1"	\$5.52	100
FNP31	31mm 1 1/4"	\$6.10	100
FNP38	38mm 1 1/2"	\$6.73	100
FNP44	44mm 1 3/4"	\$7.15	100
FNP50	50mm 2"	\$7.73	100
FNP75	75mm 3"	\$12.62	100
FNP89	89mm 3 1/2"	\$14.73	100
FNP100	100mm 4"	\$15.46	100

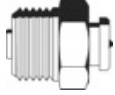
CLAVE	DESCRIPCIÓN	PRECIO POR PIEZA	E
GRASERAS 			
FNH100	1/4" -28 RECTA	\$5.20	100
FNH100LA	1/4" -28 LGA	\$9.83	100
FNH145	1/4" -28.45°	\$12.23	100
FNH190A	1/4" -28.90°	\$12.22	100
FNH200	1/8" PTF RECTA	\$8.19	100
FNH200LA	1/8" PTF LGA	\$20.14	100
FNH200LM	1/8" PTF LGA MEDIA	\$14.96	100
FNH245	1/8" PTF 45°	\$12.66	100
FNH290	1/8" PTF 90°	\$13.85	100
FNH300	1/4" PTF RECTA	\$17.06	100
*FNH51624	5/16" -24° UNEF-2A RECTA	\$4.06	100
*FNH290LMA	1/8" PTF 90° LGA M.	\$13.87	50
FNH51632	5/16 RECTA	\$7.21	100
FNH200B	1/8-27 C. BOTON	\$21.31	100
FNH300B	1/4-18 C. BOTON	\$23.35	100
FNH345	1/4-18 A 45° NPT	\$23.80	100
FNH390	1/4-18 A 90° NPT	\$23.97	100
FNH400	RECTA 3/8-18 NPT	\$47.00	100
FNH200R	REC 1/8-27 NPT	\$23.15	100
FNH316P	3/16 PRESION	\$7.69	100
FNH100GM	1/4" -28 AUTORSCANTE	\$5.15	100
FNH100V	8x1 mm AUTOROSC. 3/8"	\$7.13	100

CLAVE	DESCRIPCIÓN	PRECIO POR PIEZA	E
GRASERAS MÉTRICAS 			
FNGM06R	M6X1 RECTA	\$5.71	100
FNGM0645	M6X1 a 45°	\$13.43	100
FNGM0690	M6X1 a 90°	\$12.33	100
FNGM08R	M8X1 RECTA	\$7.78	100
FNGM0845	M8X1 a 45°	\$12.33	100
FNGM0890	M8X1 a 90°	\$12.33	100
FNGM10R	M10X1 RECTA	\$8.27	100
FNGM1045	M10X1 a 45°	\$13.87	100
FNGM1090	M10X1 a 90°	\$15.95	100



ANILLOS DE RETENCIÓN LISTA DE PRECIOS AGOSTO 2024

CLAVE	DESCRIPCIÓN	PRECIO POR PIEZA	E
ANILLOS DE RETENCIÓN INTERNOS			
FNR13025	1/4	\$2.66	100
FNR13031	5/16	\$2.60	100
FNR13037	3/8	\$2.72	100
FNR13043	7/16	\$2.78	100
FNR13045	29/64	\$2.84	100
FNR13050	1/2	\$2.95	100
FNR13056	9/16	\$3.14	100
FNR13062	5/8	\$3.29	100
FNR13068	11/16	\$3.52	100
FNR13075	3/4	\$3.70	100
FNR13077	0.777	\$3.75	100
FNR13081	13/16	\$3.77	100
FNR13086	0.866	\$3.92	100
FNR13087	7/8	\$3.88	100
FNR13090	0.901	\$4.08	100
FNR13093	15/16	\$4.27	100
FNR13100	1"	\$4.51	100
FNR13102	1.023	\$4.89	100
FNR13106	1.1/6	\$5.73	100
FNR13112	1.1/8	\$5.95	100
FNR13118	1.3/16	\$6.08	100
FNR13125	1.1/4	\$6.83	50
FNR13131	1.5/16	\$6.82	50
FNR13137	1.3/8	\$7.54	50
FNR13143	1.7/16	\$7.83	50
FNR13145	1.456	\$8.30	50
FNR13150	1.1/2	\$8.68	50
FNR13156	1.9/16	\$10.54	50
FNR13162	1.5/8	\$10.67	50
FNR13165	1.653	\$16.34	50
FNR13168	1.11/16	\$16.88	25
FNR13175	1.3/4	\$16.97	25
FNR13181	1.13/16	\$17.16	25
FNR13187	1.7/8	\$17.08	25

CLAVE	DESCRIPCIÓN	PRECIO POR PIEZA	E
ANILLOS DE RETENCIÓN INTERNOS			
FNR13193	1.15/16	\$18.19	25
FNR13200	2"	\$18.21	25
FNR13206	2.1/16	\$22.07	25
FNR13212	2.1/8	\$23.10	25
FNR13218	2.3/16	\$23.32	25
FNR13225	2.1/4	\$24.49	25
FNR13231	2.5/16	\$25.13	25
FNR13237	2.3/8	\$27.08	25
FNR13244	2.7/16	\$28.27	20
FNR13250	2.1/2	\$30.11	20
FNR13275	2.3/4	\$51.50	5
FNR13300	3"	\$64.00	5
FNR13312	3.1/8	\$92.40	5
FNR13325	3.1/4	\$92.60	5
FNR13350	3.1/2	\$108.10	5
FNR13375	3.3/4	\$132.80	5
FNR13400	4"	\$176.10	1
FNR13425	4.1/4	\$186.20	1
FNR13450	4.1/2	\$188.80	1
FNR13475	4.3/4	\$202.70	1
FNR13500	5"	\$234.00	1
FNR13525	5.1/4	\$274.50	1
FNR13537	5.3/8	\$768.90	1
FNR13550	5.1/2	\$733.20	1
FNR13575	5.3/4	\$748.30	1
FNR13600	6"	\$1,099.70	1

CLAVE	DESCRIPCIÓN	PRECIO POR PIEZA	E
ANILLOS DE RETENCIÓN EXTERNOS			
FNR14025	1/4	\$3.00	100
FNR14027	0.276	\$4.00	100
FNR14028	9/32	\$2.37	100
FNR14031	5/16	\$2.42	100
FNR14034	11/32	\$2.48	100
FNR14035	0.354	\$2.62	100
FNR14037	3/8	\$2.55	100
FNR14039	0.394	\$2.60	100
FNR14040	13/32	\$2.65	100
FNR14043	7/16	\$2.65	100
FNR14046	15/32	\$2.70	100
FNR14050	1/2	\$2.78	100
FNR14055	0.551	\$3.37	100
FNR14056	9/16	\$3.35	100
FNR14059	19/32	\$3.48	100
FNR14062	5/8	\$3.80	100
FNR14066	43/64	\$3.77	100
FNR14068	11/16	\$3.82	100
FNR14075	3/4	\$3.86	100
FNR14078	25/32	\$3.99	100
FNR14081	13/16	\$3.99	100
FNR14087	7/8	\$5.32	100
FNR14093	15/16	\$5.55	100
FNR14098	63/64	\$5.90	100
FNR14100	1"	\$6.11	100
FNR14102	1.023	\$5.80	100
FNR14106	1.1/6	\$7.72	50
FNR14112	1.1/8	\$7.26	50

CLAVE	DESCRIPCIÓN	PRECIO POR PIEZA	E
ANILLOS DE RETENCIÓN EXTERNOS			
FNR14118	1.3/16	\$7.96	50
FNR14125	1.1/4	\$9.96	50
FNR14131	1.5/16	\$10.98	50
FNR14137	1.3/8	\$8.22	50
FNR14143	1.7/16	\$12.15	50
FNR14150	1.1/2	\$12.82	50
FNR14156	1.9/16	\$15.07	50
FNR14162	1.5/8	\$15.97	50
FNR14168	1.11/16	\$20.76	25
FNR14175	1.3/4	\$17.62	25
FNR14177	1.7/72	\$20.20	25
FNR14181	1.13/16	\$20.26	25
FNR14187	1.7/8	\$20.37	25
FNR14196	1.968	\$20.53	25
FNR14200	2"	\$20.85	25
FNR14206	2.1/16	\$33.60	20
FNR14212	2.1/8	\$33.14	20
FNR14215	2.5/32	\$33.14	20
FNR14225	2.1/4	\$33.68	20
FNR14231	2.5/16	\$39.34	20
FNR14237	2.3/8	\$36.53	20
FNR14250	2.1/2	\$40.31	20
FNR14275	2.3/4	\$84.30	5
FNR14300	3"	\$90.60	5
FNR14312	3.1/8	\$101.80	5
FNR14325	3.1/4	\$99.00	5
FNR14350	3.1/2	\$110.10	5
FNR14375	3.3/4	\$158.00	5
FNR14400	4"	\$194.60	1
FNR14425	4.1/4	\$249.90	1
FNR14437	4.3/8	\$397.00	1
FNR14450	4.1/2	\$304.50	1
FNR14475	4.3/4	\$472.20	1
FNR14500	5"	\$321.00	1

*Por discontinuar



ANILLOS DE RETENCIÓN LISTA DE PRECIOS AGOSTO 2024

CLAVE	DESCRIPCIÓN	PRECIO POR PIEZA	E
ANILLOS DE RETENCIÓN EXTERNOS			
FNR14525	5.1/4	\$617.50	1
FNR14550	5.1/2	\$1,644.20	1
FNR14575	5.3/4	\$2,347.40	1
FNR14600	6"	\$2,647.90	1

CLAVE	DESCRIPCIÓN	PRECIO POR PIEZA	E
ANILLOS DE RETENCIÓN TIPO E			
FNR15006	1/16	\$0.98	100
FNR15009	3/32	\$1.10	100
FNR15011X	0.110	\$1.29	100
FNR15012	1/8	\$1.04	100
FNR15014	0.140	\$1.21	100
FNR15015	5/32	\$1.27	100
FNR15017X	0.172	\$1.33	100
FNR15018	3/16	\$1.39	100
FNR15021X	7/32	\$1.44	100
FNR15025	1/4	\$1.51	100
FNR15031X	5/16	\$1.62	100
FNR15037	3/8	\$2.08	100
FNR15043	7/16	\$2.25	100
FNR15050	1/2	\$2.83	100
FNR15062	5/8	\$4.14	100
FNR15074X	0.744	\$4.52	100
FNR15075	3/4	\$5.92	100
FNR15087	7/8	\$7.82	50
FNR15098X	0.984	\$8.85	50
FNR15118X	1.3/16	\$10.79	50
FNR15137X	1.3/8	\$16.35	25



CLAVE	NÚMERO DE PARTE	DIÁMETRO		E	PRECIO POR PIEZA
		MÍNIMO	MÁXIMO		

ABRAZADERAS LIBERTY

FAL4M	ML-4 Micro	1/4"	5/8"	10	\$8.40
FAL5M	ML-5 Micro	5/16"	3/4"	10	\$8.40
FAL6M	ML-6 Micro	1/2"	7/8"	10	\$8.40
FAL06	L-6	1/2"	7/8"	10	\$14.50
FAL08	L-8	1/2"	1"	10	\$14.90
FAL10	L-10	1/2"	1-1/8"	10	\$15.10
FAL12	L-12	1/2"	1-1/4"	10	\$15.30
FAL16	L-16	3/4"	1-1/2"	10	\$16.60
FAL20	L-20	3/4"	1-3/4"	10	\$17.60
FAL24	L-24	1"	2"	10	\$18.20
FAL28	L-28	1-1/2"	2-1/4"	10	\$19.50
FAL32	L-32	1-9/16"	2-1/2"	10	\$20.20
FAL36	L-36	2"	2-3/4"	10	\$21.40



Banda: Acero inoxidable
Carcasa: Acero al carbón tratado con resistencia a la corrosión
Tornillo: Acero al carbón. Dicromatizado
Micro: Banda de 5/16"
Regular: Banda de 1/2"

ABRAZADERAS HS

FAH4M	HS-4 Micro	1/4"	5/8"	10	\$12.00
FAH5M	HS-5 Micro	5/16"	3/4"	10	\$12.00
FAH6M	HS-6 Micro	1/2"	7/8"	10	\$12.00
FAH06	MS-6	1/2"	7/8"	10	\$20.10
FAH08	HS-8	1/2"	1"	10	\$20.80
FAH10	HS-10	1/2"	1-1/8"	10	\$20.80
FAH12	HS-12	1/2"	1-1/4"	10	\$21.20
FAH16	HS-16	3/4"	1-1/2"	10	\$21.90
FAH20	HS-20	3/4"	1-3/4"	10	\$22.40
FAH24	HS-24	1"	2"	10	\$22.90
FAH28	HS-28	1-1/2"	2-1/4"	10	\$25.20
FAH32	HS-32	1-9/16"	2-1/2"	10	\$27.90
FAH36	HS-36	2"	2-3/4"	10	\$29.90
FAH40	HS-40	2-1/4"	3"	10	\$36.00
FAH44	HS-44	2-1/2"	3-1/4"	10	\$39.20
FAH48	HS-48	2-3/4"	3-1/2"	10	\$39.20
FAH52	HS-52	3"	3-3/4"	10	\$41.40
FAH60	HS-60	3-1/2"	4-1/4"	10	\$48.20
FAH72	HS-72	4"	5"	10	\$49.00
FAH88	HS-88	5"	6"	10	\$57.40
FAH96	HS-96	5-1/2"	6-1/2"	10	\$59.90
FAH104	HS-104	6"	7"	10	\$66.70



Banda: Acero inoxidable AISI 201
1/2" de ancho, alta resistencia, ensamblada, no soldada ni remachada
Carcasa: Acero inoxidable AISI 201
Tornillo: Acero al carbón
Micro: Banda de 5/16"
Regular: Banda de 1/2"



CLAVE	NÚMERO DE PARTE	DIÁMETRO		E	PRECIO POR PIEZA
		MÍNIMO	MÁXIMO		

ABRAZADERAS TB PARA TRABAJO PESADO

FAT138	TB-138	1-3/8"	1-9/16"	1	\$189.50
FAT150	TB-150	1-1/2"	1-11/16"	1	\$191.60
FAT200	TB-200	2"	2-5/16"	1	\$184.90
FAT250	TB-250	2-1/2"	2-13/16"	1	\$190.40
FAT275	TB-275	2-3/4"	3-1/16"	1	\$194.00
FAT300	TB-300	3"	3-5/16"	1	\$196.60
FAT325	TB-325	3-1/4"	3-9/16"	1	\$199.60
FAT350	TB-350	3-1/2"	3-13/16"	1	\$199.70
FAT400	TB-400	4"	4-5/16"	1	\$204.90
FAT450	TB-450	4-1/2"	4-13/16"	1	\$209.60

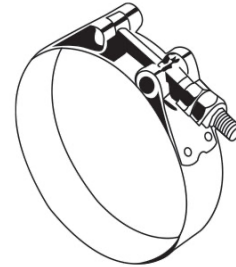

Banda: Acero inoxidable 300

Puente: Acero inoxidable 300

Perno: Acero al carbón

Tuerca: Acero al carbón con inserto de nylon

Buje: Acero al carbón

ABRAZADERAS TB PARA TRABAJO PESADO CON RESORTE

FAB225	TBS-225	2-1/4"	2-9/16"	1	\$223.50
FAB275	TBS-275	2-3/4"	3-1/16"	1	\$215.30
FAB300	TBS-300	3"	3-5/16"	1	\$225.50
FAB325	TBS-325	3-1/4"	3-9/16"	1	\$254.30
FAB350	TBS-350	3-1/2"	3-13/16"	1	\$228.80
FAB375	TBS-375	3-3/4"	4-1/16"	1	\$241.40
FAB400	TBS-400	4"	4-5/16"	1	\$243.60
FAB425	TBS-425	4-1/4"	4-9/16"	1	\$246.10
FAB450	TBS-450	4-1/2"	4-13/16"	1	\$246.10

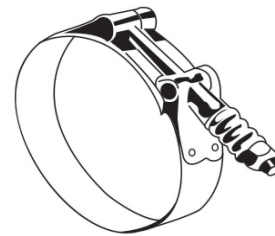

Banda: Acero inoxidable 300

Puente: Acero inoxidable 300

Perno: Acero al carbón

Tuerca: Acero al carbón con inserto de nylon

Buje: Acero al carbón

Resorte: Acero al carbón



CLAVE	NÚMERO DE PARTE	DIÁMETRO		E	PRECIO POR PIEZA
		MÍNIMO	MÁXIMO		

ABRAZADERAS PARA BOTA DE TRANSMISIÓN

FAM8	MS-8	1/2"	1"	10	\$16.50
FAM10	MS-10	1/2"	1-1/16"	10	\$16.50
FAM12	MS-12	1/2"	1-1/4"	10	\$16.50
FAM16	MS-16	3/4"	1-1/2"	10	\$16.50
FAM20	MS-20	3/4"	1-3/4"	10	\$17.70
FAM24	MS-24	1"	2"	10	\$18.40
FAM28	MS-28	1-1/2"	2-1/4"	10	\$19.00
FAM32	MS-32	1-9/16"	2-1/2"	10	\$19.70
FAM44	MS-44	2-1/2"	3-1/4"	10	\$32.40
FAM48	MS-48	2-3/4"	3-1/2"	10	\$34.20
FAM52	MS-52	3"	3-3/4"	10	\$34.20
FAM56	MS-56	3"	4"	10	\$34.20
FAM60	MS-60	3-1/2"	4-1/4"	10	\$35.20



Banda: Acero inoxidable 301
Carcasa: Acero inoxidable 301
Tornillo: Acero al carbón dicromatizado
Banda regular: 1/2"
Banda micro: 5/16"